

DEBATING THE USE OF LOST-WAX CASTING IN ANCIENT CHINA

FORBES LECTURE ON SCIENTIFIC
RESEARCH IN THE FIELD OF
ASIAN ART



FORBES LECTURE ON SCIENTIFIC RESEARCH IN THE FIELD OF ASIAN ART

This Forbes lecture was given on January 15, 2015, at the Freer Gallery of Art. Interest in this topic has increased since the lecture was given. See papers by Notis and Wang 2017 and Peng 2017.

© 2019 Freer Gallery of Art and Arthur M. Sackler Gallery, Smithsonian, Washington, DC.
All rights reserved.

This is a not-for-profit educational tool for use by the public and as a scholarly research supplement.

The Freer|Sackler has no responsibility for the persistence or accuracy of URLs for external or third-party websites referred to in this publication and does not guarantee that any content on such websites is, or will remain, accurate or appropriate.

Edited by Ann Hofstra Grogg

Proofread by Ian Fry

Designed by Adina Brosnan McGee

FREER|SACKLER



On the cover: *Dui grain vessel, China, Eastern Zhou (6th century BCE), copper alloy, H. 20.3 cm. The Metropolitan Museum of Art, 1992.165.24. Image © The Metropolitan Museum of Art.*

Debating the Use of Lost-Wax Casting in Ancient China

Donna Strahan

The Freer Gallery of Art and Arthur M. Sackler Gallery's Department of Conservation and Scientific Research holds as its preeminent goal the advancement of conservation and scientific study of the Freer and Sackler collections, related materials, and Asian art as a whole. The department originated as the Freer Gallery Laboratory for Technical Studies in Oriental Art and Archaeology, established at the Freer in 1951 by Rutherford John Gettens, whose main research focus was the technical study of ancient Chinese bronzes (Gettens 1969, xv)(fig. 1). The next two heads of the department, W. Thomas Chase and Paul Jett, expanded the field of technical studies (fig. 2), and in the course of the last sixty-five years many new bronze finds and analytical studies have increased our understanding of these ancient objects. Scholars and scientists who have studied bronzes at the Freer|Sackler include Robert W. Bagley, Noel Barnard, Ilona V. Bene, James Cahill, Elisabeth FitzHugh, Lore Holmes, Thomas Lawton, Li Chi, Pieter Meyers, John Alexander Pope, Masuru Sekino, Cyril Stanley Smith,



Figure 1. Rutherford J. Gettens (left) and Director John A. Pope (right) examining an X-radiograph of a bronze in the Freer laboratory, 1969. Photo by W. T. Chase. **Figure 2.** W. Thomas Chase examining a bronze object, 2010. Photo by Francesca Bewer.

Jenny So, Sueji Umehara, and Archibald Gibson Wenley. Now, as the head of this distinguished department, I am pleased to continue the technical study of bronzes with this examination of a topic that is hotly debated: whether the process of lost-wax casting was known in Bronze Age China, that is, before the Qin and Han dynasties, pre-221 BCE.

First, as background, I offer a summary of the history of Chinese bronze studies, followed by a general explanation of lost-wax casting and piece-mold casting. Then, a detailed examination of three objects presents the issues to clarify why it is so difficult for scholars to agree on the casting techniques. The essay concludes with recommendations of areas for future study to help further our understanding.

There are two major techniques for casting bronze: the lost-wax technique and the piece-mold technique. In the ancient Near East, as far back as 3500 BCE, artisans began smelting metal and hammering it into sheets from simple cast ingots. By the seventh century BCE, lost-wax casting and simple piece molds were a part of Western foundry practice. Artisans used smithy work for vessels and lost-wax casting for sculptural forms and other objects (Davey 2009). These techniques sharply contrast with what was happening at the same time in the Central Plain of China. There, by the Shang dynasty (13th–11th centuries BCE), elaborate piece-mold casting methods had developed (Chase 1991, 31–34) (fig. 3).

History of Bronze Casting Technology Studies

As Gettens noted, references to metals technology in ancient Chinese literature are rare (Gettens 1969, 14). Influenced by practices in the ancient Near East, Western scholars of early bronze casting techniques in China labeled them all as lost-wax-cast. This view changed when the ancient site of Anyang began to be excavated in 1928 and 1929 under the sponsorship of the Freer Gallery of Art (Li 1977, 56–59). When Shang dynasty clay mold fragments unearthed at Anyang were published between 1929 and 1933 (Anyang fa-chüeh pao-kao 1929–33; Li, C. 1977), an entirely new approach to bronze casting in China was introduced. Orvar Karlbeck, a Swedish engineer who acquired 170 clay mold fragments from Anyang in 1935, believed that they had been impressed from a sculpted ceramic pattern or model and that wax had not played any part in the casting (Karlbeck 1935, 44).

In 1961 Noel Barnard published a comprehensive study of bronze casting in ancient China. He agreed with Karlbeck's theory of piece-mold casting, in which the designs were formed on the pattern or model rather than on the mold surface (Barnard 1961). He further developed the theory

Figure 3. *Vessel (ding), Anyang style, 12th century BCE, bronze, H. 24.8 cm. Freer Gallery of Art, F1960.18. Piece-mold-cast.*



with Shih Changju, who had participated in the Anyang excavations. At about the same time, Anyang archaeologist Li Chi and metallurgical engineer Wan Chiabao, who studied the mold fragments at the Institute of History and Philology in Taipei, also concluded that the bronzes were created by piece-mold casting, not lost-wax casting (Li and Wan 1964).

In 1962 Wilma Fairbank suggested that the piece-mold method was an outgrowth of the earlier mastery of ceramic technology by the Chinese, which involved management of elevated kiln temperatures necessary for metallurgical development. Use of piece molds made possible a direct transition from making pottery vessels to producing the same or similar shapes in bronze. The piece-mold method allowed both the shape and decoration to be produced at the same time (Fairbank 1962, 10–11). Scholars began to realize that by the 13th century BCE metalworkers in Shang China's Central Plain had developed a unique ceramic method of piece-mold casting bronzes to an unprecedented degree of complexity (Kerr and Wood 2004, 396–404). For the next thousand years it was the standard method.

Back at the Freer, in 1979 Barbara Keyser was able to reconstruct the immensely complicated mold-making procedure of the Eastern Zhou period (770–256 BCE), explaining how repeated pattern blocks were used to make designs in molds (Keyser 1979). Chase's 1991 exhibition and catalog at the China Institute confirmed a general agreement among scholars that piece-mold

casting was the only technique used in the Central Plain until the Eastern Zhou (Chase 1991, 34). Meanwhile, in support of this theory, in 1957 the remains of the 5th century BCE foundry of Houma were discovered in southwest Shanxi Province and published in 1996 (Li and Liang 1996). The several thousand pieces of clay casting debris included baked pieces of decorated clay that were used as positives for replicating single units of decoration into the surface of a mold. These were not broken fragments of decorated models but evidence of a technical development, from placing the design on the pattern or model and incising only a few details in the mold, to decorating the mold surface directly. Robert W. Bagley took a closer look at piece-mold casting for a better understanding of how mold pieces were decorated to achieve a desired pattern. His critical sense led to insightful observations about aesthetic and technical processes (Bagley 2009). Before this he had noted that as early as the pre-Shang period there was a long heritage of casting vessels, and that the piece-mold method had been adequate for producing a narrow range of objects, mainly vessels. With plenty of metal and imperial support, it was not necessary to produce thin-walled castings. Occasionally in the Eastern Zhou lost-wax-cast parts were attached to piece-mold-cast vessels. The Chinese probably knew the lost-wax technique but determined that piece-mold casting worked best (Bagley 1987, 44–45).

Little research on these topics was done in China until after the Cultural Revolution (1966–78). By the 1980s Chinese scholars began to look at clay models, molds, casting defects, and repairs on some of the most important excavated objects from the Shang and Western Zhou dynasties and to publish investigations of the casting details. Today numerous scholars in China are studying ancient bronze technology. Along with newly excavated bronzes, their findings are expanding our understanding at a fast pace. However, most of the research is published only in Chinese and is not easily accessible.

In 1977 in Suizhou, Hubei province, several extraordinary bronzes were discovered in the tomb of the Marquis Yi of Zeng (Zenghouyi), which dates to 433 BCE (Beijing 1989). This tomb was one of only a handful of ancient Chinese royal tombs discovered intact and then excavated using modern archaeological methods. Zeng was a minor state, subordinate to its powerful neighbor Chu. Among the bronzes discovered there are two incredibly intricate, openwork vessels with elaborate projections—a vessel (*zun*) with its plate (*pan*) (fig. 4)—that led some scholars to conclude they could have been cast only by the lost-wax method. Since then, the question of whether these two Zenghouyi vessels were piece-mold-cast or lost-wax-cast has become a hot topic in academic circles in China, explored by archaeologists, artists, conservators, and mechanical engineers. Numerous papers published in Chinese support both sides of the argument.

The main question is whether lost-wax casting ever existed in the Central Plain during the Bronze Age of China, that is, through the Eastern Zhou. Scholars on one side of the debate say there was

Figure 4. Bronze vessel (zun) and plate (pan) from the tomb of the Marquis Yi of Zeng (Zenghouyi), Warring States Period (circa first half of the 5th century BCE), zun H. 30.1 cm, diam. at mouth 25 cm; pan H. 23.5 cm, diam. at mouth 58 cm. Hubei Provincial Museum, Hubei, China. After Xiaoneng Yang, ed., *The Golden Age of Chinese Archaeology: Celebrated Discoveries from the People's Republic of China* (New Haven: Yale University Press, 1999), 284.



no lost-wax casting in the Central Plain until after the Han (220 CE) and perhaps not until the arrival of Buddhism in the 4th century CE (Zhou and Huang 2015a; Wang 2002). Scholars on the other side of the debate think lost-wax casting appeared in Eastern Zhou with the openwork Zenghouyi vessels, that is, by 433 BCE (Hua and Xiao 2005, 80–89; Li 1980, 64; Li et al. 2007; Tan 1989, 51–58). If lost-wax casting began in the Eastern Zhou, did it continue to be used during the later Qin-Han periods (221 BCE–221 CE)? Piece-mold casting was still in use when Buddhism arrived in the region. To date, of the Central Plain images studied, all were found to be piece-mold-cast up until the 6th century CE. Only then do images begin to be made by the lost-wax method (Strahan 2012).

In addition, only piece-mold foundries have to date been excavated. No lost-wax casting workshops have been identified, and it is likely that the large, assembly-line type, piece-mold casting foundries in the Central Plain were not conducive to the lost-wax process (Bagley 1987, 17–18), which places most of the skill in one crafts worker's hands. The one who creates the wax model must understand all the requirements for pouring the metal and its potential problems. Furthermore, once the wax model is enclosed in investment material, no further changes can be made. Therefore, the foundry workers who actually melted and poured the metal would not be able to make alterations as they could with piece-mold sections (Franklin 1992, 18–24). The established piece-mold process would be difficult to replace. The direction of technological innovation tends toward improvement of existing methods rather than the adoption of a completely new system. At these large foundries, any change in one unit of the workshop would affect all other units in the production system. Such a change would be disruptive and slow to occur.

In recent years archaeological excavations in China's Central Plain have unearthed a few more elaborate openwork Eastern Zhou bronze artifacts (Zhou and Huang 2015b; Loveday 2002). Because of their convoluted openwork patterns, many have the appearance of being lost-wax-cast. At the same time, thousands of more typical piece-mold-cast bronzes have been found in this region. Were the openwork artifacts lost-wax experiments, a combination of lost-wax and piece-mold techniques, or merely spectacularly elaborate piece-mold castings?

To help answer these questions, I will discuss the Zenghouyi *pan* and *zun* in greater detail as well as two other objects on which scholars cannot agree. But first I will briefly review how lost-wax and piece-mold casting are carried out.

Casting Techniques

Lost-wax casting

Lost-wax casting can be carried out by the direct method or the indirect method. Direct lost-wax casting produces a single image, since the original model is melted out and lost. Objects made by this method can be either block-like or naturalistic, with many projections and deep undercuts in all directions. Through the use of armatures, cores, and a highly malleable material such as wax, very expressive shapes can be created.

After the wax model is created, wax gates and sprues are added so the poured metal will be distributed evenly throughout the casting. These also provide routes for gases to escape, thus avoiding excessive porosity, cold shuts, and other casting flaws. During the casting process, these wax sprues are replaced with metal (fig. 5).

Using the indirect method requires a piece-mold to be taken off a model. Once removed from the model, the mold pieces are put together and lined with wax. The cavity, therefore, is accessible during the mold-making process, and sometimes evidence of this step survives on the interior walls. For example, if molten wax was poured or brushed into the mold, then drip or brush marks might be present in the metal. If, instead, wax sheets were pressed in, then fingerprints, tool marks, or seam lines may be visible. On rare occasions, in large sculptures, internal wax struts or feeders and vents may have been used to assist the flow of metal from one area to another and into the entire mold as quickly as possible, thereby avoiding gaps in the cast. In the casting process, the wax of the struts is replaced by metal, and these are visible on the interior or in radiographs. Then

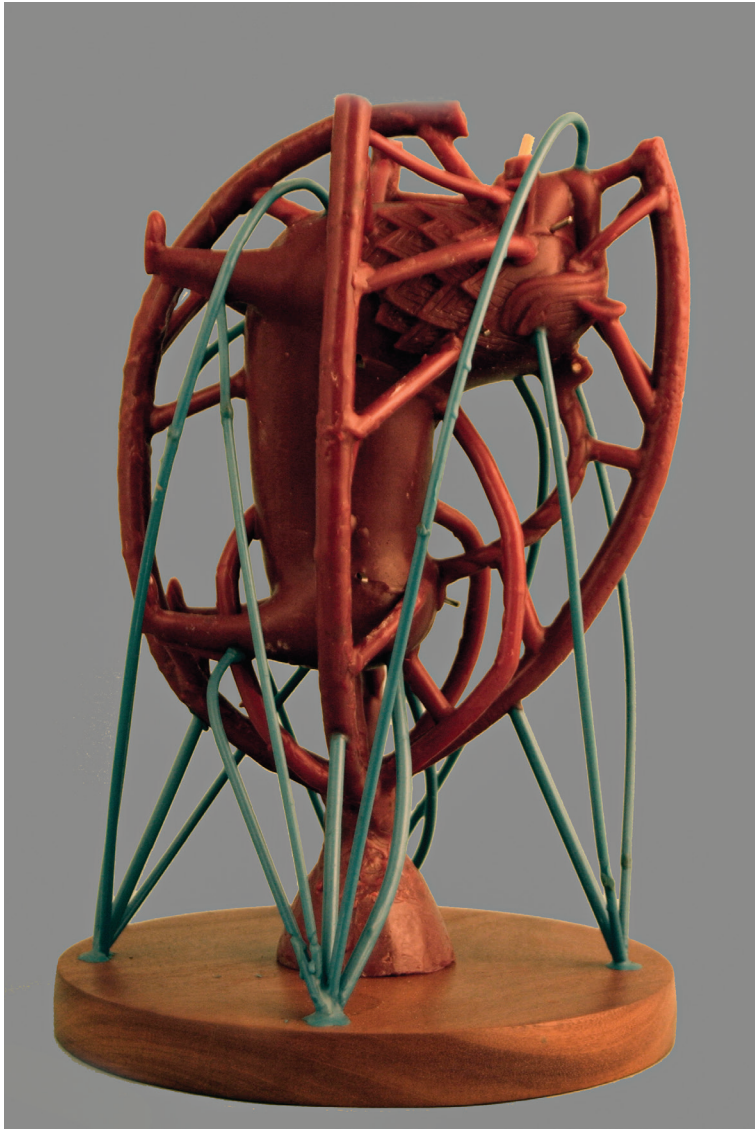

Figure 5. *Wax model of reproduction medieval aquamanile with sprues and gates attached prior to casting. Created and photographed by Pete Dandridge/Objects Conservation/Image © The Metropolitan Museum of Art.*

a core fills the hollow, the mold is disassembled, and independently modeled wax components are appended. Before it is invested, surface detail can be scored into the wax model.

Both direct and indirect hollow lost-wax casting depend on core supports to hold the core in the investment once the wax has been melted out and until the molten metal is poured in. These are usually core pins that can be left in the finished sculpture or removed, leaving a void that can be filled with plugs, either hammered in position or cast in situ. Casting is the easy part; the hard part is the finishing. All vents, sprues, and gates become metal during casting. Now they must be cut off. Flaws are filled in, and the surface is polished.

Piece-mold casting

Piece-mold casting usually starts with a preliminary model, probably made of clay with or without designs. Taking a mold from the model requires the mold sections to be made in segments. In this way the crafts worker has access to the mold to add other parts, designs, and keys around the edges that allow the correct reassembly of the mold sections for casting. The mold sections are made in as many parts as necessary, as long as they can be taken off the model without being damaged. Thus, all undercuts have to be avoided or the mold will be damaged. Figure 6 illustrates how many mold pieces are necessary to produce a vessel (fig. 6). The few fragments of ancient models that have been found are clay, but models could also have been made of wood, resin, wax, animal fat, bitumen, or a mixture of materials. The model had to be strong enough to withstand the clay molds being removed from it. In figure 7 an elaborate, openwork Houma model illustrates how three-dimensional some piece-mold casting could be (fig. 7). One can also cast bronzes without a model by starting with the fabrication of the mold. After the mold is complete and fired one can fill it with clay to make the core, disassemble the piece-mold along mold joints, thin down the core to establish the casting space, reassemble the mold and core, and cast the vessel.

After the mold sections are dismantled from the model, the crafts worker has access to the interior mold surfaces, which could be carved and decorated. Therefore, both the model and the mold could carry some of the decoration that appears on the finished bronze. After the mold sections are made, the model is shaved down to serve as the core, reduced just enough to allow for the desired thickness of the finished cast-metal vessel. Enough material had to be removed to permit the unrestricted flow of molten metal during casting. Furthermore, the space between the core and the mold had to be wide enough to give the metal sufficient structural integrity to withstand subsequent finishing.

In preparation for casting, as the mold pieces are being reassembled, small metal spacers, the thickness of the desired finished object, are placed at intervals between the core and mold sections to hold the mold sections apart from the core during casting. The metal spacers become incorporated within the freshly poured metal upon solidification. The reassembled mold pieces are then encased in a refractory or investment material, or bound together for casting.

Invariably during casting, metal seams develop along mold joins on the exterior surfaces of the cast. Most of these are removed during the finishing process, but often traces can be detected, if not on the surface of the object itself then in x-radiographs. Finishing a piece-mold-cast object is much simpler than finishing one made by lost-wax casting. With a piece-mold-cast object, the fins are cut off and the surface is given a smoothing and polishing with abrasives. Any major flaws are cast-in.

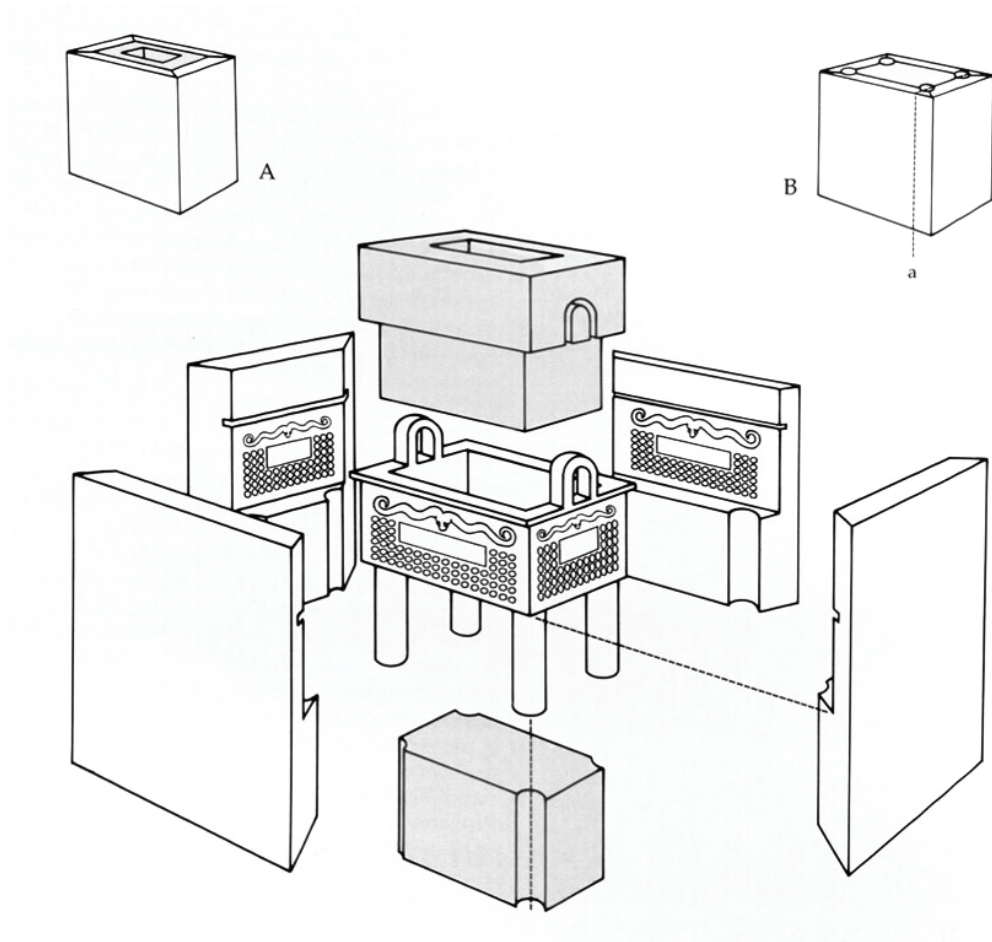

Figure 6. *Mold pieces needed for casting a square vessel (fang ding). After Chase 1991, 24. Reassembled molds are shown in inset A; the assembly is inverted with legs up when the molten metal is ready to pour as shown in inset B.*

Figure 7. *Houma clay model after Li and Liang 1996, 182, 94.*



Case Studies

An examination of four Eastern Zhou openwork objects with the above descriptions of casting processes in mind demonstrates how difficult it is to understand their fabrication methods and why there is disagreement. Because no lost-wax casting workshops have been identified, only the objects themselves can provide evidence.

Zenghouyi zun and pan

When the tomb of Zenghouyi was discovered in Hubei, its two fantastic, lively openwork wine vessel and bowl (*zun* and *pan*) astonished everyone (fig. 4). As researchers began to closely examine them and other recently excavated openwork vessels, the debate over whether they were piece-mold-cast or lost-wax-cast began. In 1989 Tan Derui of the Shanghai Museum published the *Zenghouyi* vessels as the beginning of the use of lost-wax casting in China (Tan 1989, 51–58), and today the majority of researchers think that some of the openwork parts of the Zenghouyi wine vessels were lost-wax-cast. But could they be piece-mold-cast?

Most researchers agree the *zun* was made in four separate parts (foot, body, neck, and rim) and fusion-welded together. They also agree that the rim of the vessel was made in four separate parts and fusion-welded or soldered together (fig. 8). The general design is quite flat; thus it would have been possible to carve into a mold. Disagreement arises on how the individual sections were made (Zhang 2007). Both sides of the argument point to evidence on the objects. Piece-mold-cast proponents Zhou Weirong (Numismatic Museum), Wang Jinchao (Nanjing Museum), and Dong Yawei (Nanjing Museum) believe there was no lost-wax casting in Bronze Age China (Zhou et al. 2006; Zhou and Huang 2015a). Lost-wax proponents Tan Derui (Shanghai Museum), Huang Jinzhou (Suizhou, Hebei province), and Hua Jueming (Chinese Academy of Sciences) believe that lost-wax casting came into use for specific objects in the Central Plains in the Eastern Zhou period (Tan 2007; Huang 2008; Hua 2010).

The piece-mold proponents find piece-mold casting evidence between the top rim and neck of the *zun*, the location of flow fusion-welded seams, where the irregular line across the middle (white arrow in fig. 9) reveals that the mold was adjusted to get a good casting. This area would be a high point during the pour, allowing for shrinkage of the molten metal. Similar seams can be found in Shang, Zhou, and Han piece-mold-cast vessels. Wang Jinchao made reproductions of Zenghouyi parts using piece-molds to demonstrate how the vessel could have been created (fig. 10), and he points out how regular in size and shape the pieces are (Wang 2002).

Tan Derui, Hua Jueming (Chinese Academy of Sciences), and Chao Shigang (Henan Provincial Archaeological Institute) counter that both piece-mold and lost-wax casting were used on the same

Top to bottom

Figure 8. Zenghouyi zun (fig. 4) with separately cast sections identified. After Huang et al. 2008, 99, fig. 1. The numbers identify the four main sections that were cast separately. Disagreement on how the top section (4) was cast is ongoing.

Figure 9. Location of welded seams on the interior of the Zenghouyi zun (fig. 4) between the upper rim and neck. The white arrow shows where the mold was adjusted prior to casting. After Zhou et al. 2006, color fig. 1.

Figure 10. A section of Wang Jinchao's reproduction of the Zenghouyi zun (fig. 4) made by piece-mold casting. After Zhou and Huang 2015, 1634, fig. 8.



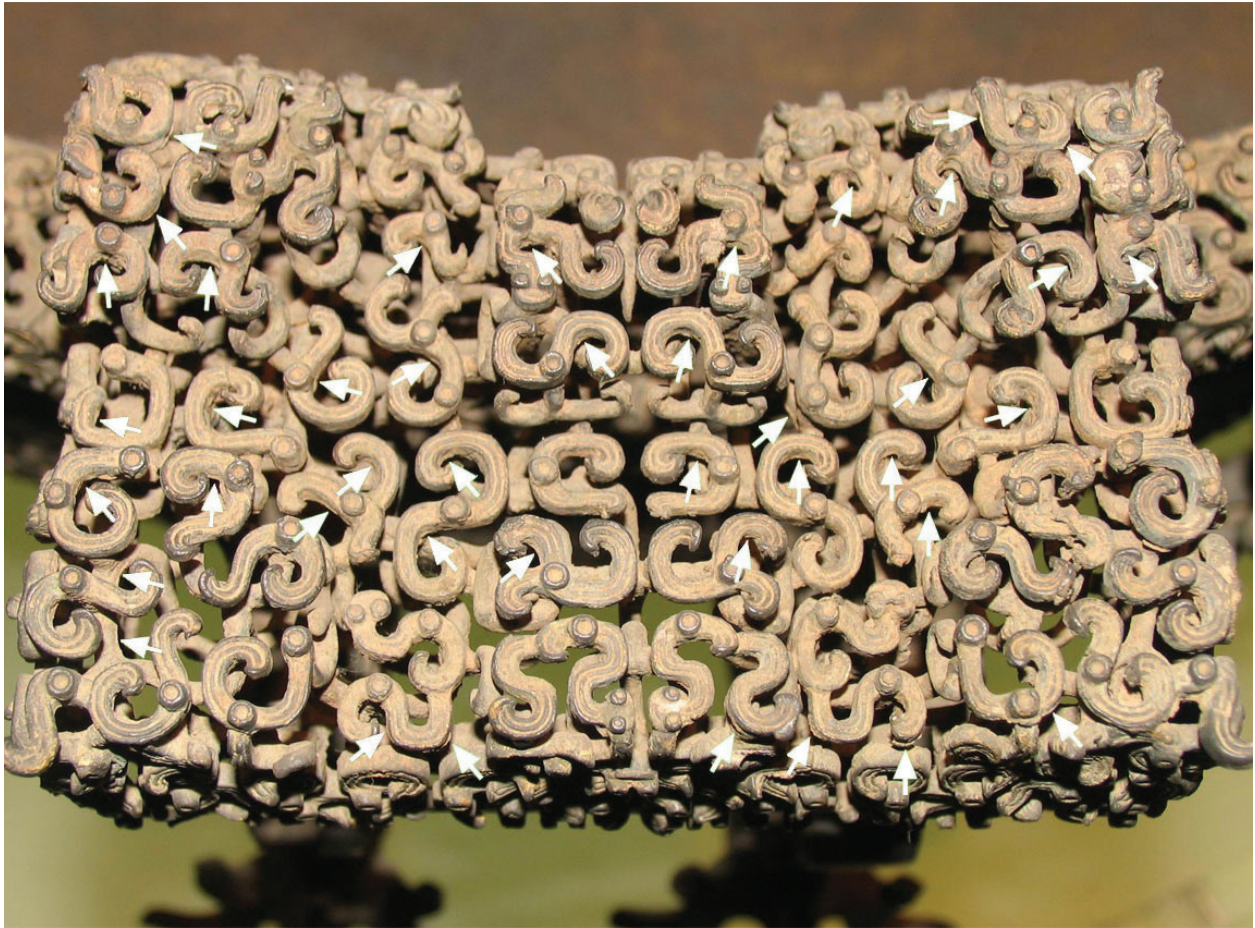

Figure 11. *Detail of snakes/dragons design on the Zenghouyi zun (fig. 4) with arrows pointing to casting fins. They could have been formed either by lost-wax casting or by piece-mold casting. After Huang et al. 2008, 101, fig. 6.*

openwork vessels (CCTV videos 2010), and Hua Jueming claims that Wang Jinchao's reproduction runners are too straight and that the original objects would have had irregular-shaped runners.

Casting fins are found around all edges of the snakes and dragons (fig. 11). On the lost-wax casting side, Tan Derui says the fins were made by pressing wax into a mold and not removing them when they were taken out of the mold. All the individual parts were joined by melting each little piece together in the wax state, and, once complete, the wax section was cast as one unit. The piece-mold casting proponents say it was impossible to put that many wax pieces together without having huge distortions. They contend that the *zun*'s edge is where sections of decoration were welded together at an intersecting 90 degree angle. Dong Yawei asserts that each little snake or dragon piece was cast separately, then combined by fusion-welding or soldering. Each welded section is different, and these scholars estimate the vessel was made up of about 3,000 subunits. But lost-wax proponent Tan Derui says that so many little metal pieces would be needed that putting all of them together would not work. W. Thomas Chase thinks that one of the important questions is the morphology of these casting fins and how they line up. If they are leftovers from trimming individual wax elements (as per Tan Derui) then they probably would not line up. The individual morphology may be quite different due to how well the wax pieces were trimmed after removal from the mold. If they are from piece-mold casting there should be more regularity in direction and thickness. On looking at figure 11 these casting fins are pretty irregular, thereby indicating that they were from trimming individual wax pieces (W. Thomas Chase, personal communication, July 24, 2018).

Other scholars such as Wan Li (Nanjing Museum) who have published on the fabrication of the openwork vessels admit that they do not know how they were made (Wan 2013). One researcher, Fan Taofeng (Nanjing Museum), used x-ray fluorescence analysis to nondestructively analyze a small openwork pot (known as the Chen Zhang Pot) and found it to be made of many separate parts, all soldered together (Fan et al. 2013). Among Western scholars working on this topic, Robert Bagley, W. Thomas Chase, and Helen Loveday say both piece-mold casting and lost-wax casting were used on openwork vessels (Bagley 1987, 37; Chase 1991, 34; Loveday 2002, 102).

Both sides of the debate are well supported. Clearly the next step is to analyze openwork objects using micro stereo-radiography, computed tomography (CT) scans, synchrotron X-ray microfluorescence imaging, and x-ray fluorescence analysis of the joins. If the alloy of the joins is the same as the body, then the object was cast at one time and no solder was used. This finding would point to lost-wax casting. If the joins are an alloy different from that of the body, then the pieces were cast separately and fusion-welded or soldered together. This finding would point to piece-mold casting. Recently Michael R. Notis (Lehigh University) and Dong Ning Wang (Lehigh University) were able to study CT scans of the *zun*, and they suggest it would be easier to cast the top section with lost-wax casting (Notis and Wang 2017).

Metropolitan Museum of Art incense burner

The object in the Metropolitan Museum of Art is called an incense burner, although how exactly it was used is unclear (fig. 12). A similar vessel was excavated at Fengxiang in Shaanxi and is now in the Fengxiang County Museum (Jing and Wang 1996) (fig. 13). While I have not examined the excavated Fengxiang piece, photographs suggest that the base and other attachments were piece-mold-cast. The Metropolitan piece must originally have had a base similar to this one, but today it has three feet attached with modern solder. The designs of the two objects' openwork spheres are different. The Fengxiang sphere is more open, rounded, and less tightly aligned.

Loveday writes, "The similarities between the Fengxiang burner and the Metropolitan vessel are striking: once again, a raised band with four ring-holding animal masks runs around the central part of the body, and a large bird with open wings stands on the apex. Furthermore, the Chinese report describes a round opening in the center of the bird's back that connects with the cavity in the middle of the sphere. Another, much larger, circular opening is to be found in the outer shell, under the vessel. Both these features can also be seen on the Metropolitan piece" (Loveday 2002, 111). The main difference between them is the shape of the outer sphere open design. Fengxiang is more open and interwoven while the Met consists of outer horizontal bands connected to inner vertical bands. Tan Derui and Hua Jueming (Chinese Academy of Sciences) say the Fengxiang was lost-wax cast (Hua 2010). Zhou Weirong and Dong Yawei say it was piece-mold-cast (Zhou et al. 2006; Zhou et al. 2009). I had the opportunity to study the Metropolitan vessel in great detail.

The three-dimensional complexity of the Metropolitan vessel is extraordinary (fig. 14). It is made up of eighteen separately cast pieces. Prior to its arrival in the Metropolitan Museum, multiple pieces of the vessel were soldered together with modern solder. Its unusual shape and modern solder have caused some scholars to accept it as a pastiche. At the request of the curator, the modern solder was removed, thereby providing access to the surface of the inner sphere as well as the interior of the lower hemisphere. None of the ancient solder was touched. While the feet are ancient, both their shape and alloy composition confirm they do not belong to this vessel, providing further evidence that the object stood on a different base.¹ The four equatorial bands are also additions held on with modern solder. Although the casting method of the incense burner is not completely understood, evidence thus far points predominately to piece-mold casting.

The four small birds and four decorative heads were each piece-molded from a single model and then cast to produce multiples. The two openwork hemispheres were soldered to the inner sphere in four places, and the remains of ancient solder are still present. Then the birds and decorative heads were also soldered onto the outside of the hemispheres. They have a modern solder on top of ancient solder. This complex vessel demonstrates the very sophisticated use of piece-molds and the replication of design created in several stages.



Clockwise from top left

Figure 12. *Incense burner, China, Eastern Zhou (5th–4th century BCE), copper alloy overall, H. 21.9 cm. The Metropolitan Museum of Art, 1947.25. Photo by Donna Strahan/Objects Conservation/Image © The Metropolitan Museum of Art.*

Figure 13. *Vessel excavated in 1997 now in Fengxiang County Museum., bronze, H. 34 cm. The Metropolitan Museum's vessel (fig. 12) probably originally had a similar base. Photo from Treasures of Ancient China, Tokyo National Museum (Tokyo: Asahi Shinbunsha, 2004), 61.*

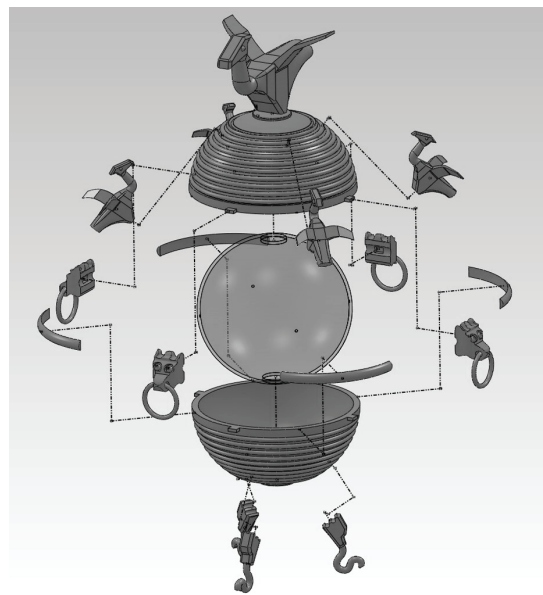

Figure 14. *Metropolitan incense burner (fig. 12), exploded view, showing the separately cast parts. Illustration by Corey J. Tucker.*



Figure 15. Detail of phoenix on the Metropolitan incense burner (fig. 12), showing pyramidal core extensions on the surface. Figures 15, 16, 18, 20, and 21 photos by Donna Strahan /Objects Conservation/ Image © The Metropolitan Museum of Art.



Figure 18. Mold seam on the lower hemisphere of the Metropolitan incense burner (fig. 12), where two mold sections were joined during casting.

The inner plain, hollow sphere was cast in one piece. The mold assemblage consisted of a central clay core and two outer mold sections. Round core extensions protruded outward at each pole. They were used to hold the outer mold sections apart from the core during casting. No core pins or spacers were used, and most of the core was removed from the interior after casting, leaving the sphere hollow. All evidence of exterior mold seams was removed during finishing, thereby producing a perfectly round, smooth hollow sphere.

The sphere is enclosed in two openwork hemispheres that make up an outer decorative shell. They have an elaborate three-dimensional openwork design of intertwined snakes. A phoenix, standing on a circular plate, was fusion-welded onto the top of the upper hemisphere. Metal flashing at the join can be seen on the interior of the sphere. The large phoenix was piece-mold-cast with an enclosed core. Small pyramidal core extensions are located around its body (fig. 15). Pyramidal core extensions were a common method at this time for keeping a completely enclosed core away from the outer mold sections during casting (Gettens 1969, 80; Li and Liang 1996, 485). The decoration is typical of Eastern Zhou vessels with interlaced zoomorphic forms in horizontal bands extending around its circumference. Bagley believes that this type of a linear decoration is unlikely to occur in lost-wax casting because a mold made by the lost-wax method is closed and can be worked only on the wax model. He notes that the pattern used here is constrained by the piece-mold section. The design was drawn only on one of the mold sections. It is therefore confined by the arc spanned by that section. The side boundaries of the design correspond to the vertical

lines of the mold joins. It was easier and more natural to draw pattern units that were complete within a single mold section. The decoration that resulted on the cast object was then composed of self-contained units whose boundaries clearly showed the divisions of the mold assembly. This casting method constrained how a bronze was decorated (Bagley 1987, 18).

This description of linear decoration clearly coincides with what is found in the Metropolitan incense burner. The model for each hemisphere was a perfect dome, probably made of clay and produced by a rigid profile jig. After the dome-shaped model was made, only one quarter of it was decorated.

A closer study of the bottom hemisphere (fig. 18) reveals that the design is made up of two registers. The design of the openwork upper register is composed of horizontal bands of snakes with a repeating head-tail pattern. The bands are connected to each other on the interior by vertical stepped C-shaped forms. These vertical C-shaped forms are often sloppy, as they would not be seen once the object was completed (fig. 16).

The lower register is composed of a repeating diagonal, twisted snake-like design. This register is less three-dimensional than the upper register (figs. 16, 20, 21). It was probably formed of a front and back mold with core extensions through the design to hold the sections in place. Vertical mold seams in some places can be seen where the front and back mold sections came together (see fig. 20). A few holes in the openwork are partly blocked by metal fins, where metal seeped out between the mold seams during casting. The disk-shaped bottom plate was also part of the openwork design using core extensions in its five holes to keep the front and back molds in place (fig. 16).

Because the design of the openwork upper register is more complicated and both registers were cast together, its process of casting requires more consideration. This is how the upper register could be piece-mold-cast. The exterior horizontal design including the simpler lower register was first created in the positive on a single quarter of the model, then fired.

Then, an impression was taken of the design, creating a negative image of the snakes (mold piece A). Next, an impression of that impression was taken, so the snakes are positive again (mold piece B). On this impression, the snakes are carved away leaving slight depressions in their place. These depressions provide good locations for holes.² Then, holes were made through the piece wherever connections were needed. These two pieces were reassembled for ease of handling. The whole assembly was turned over and the C-shaped vertical connections were carved in between the holes, spanning over one horizontal row. This creates two mold pieces: one for the exterior design (A) and one for the interior (B). At this point, three more mold pieces were pulled from the initial model with the horizontal snakes; and three negative molds were made from mold B with the vertical C-shaped connections. Then, the pieces are assembled to form a complete dome with the lower sections included.



Figure 16. *Interior of lower hemisphere. The upper registrar has vertical rows tied to the horizontal rows by a series of stepped C-shaped forms.*

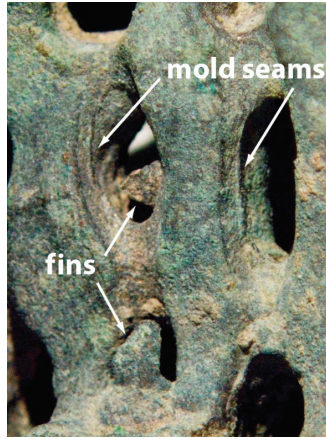

Figure 20. *Detail of interior of the lower hemisphere (fig. 16) of the incense burner lower register just below fig. 21. Mold lines and metal fins produced during casting are marked with arrows.*

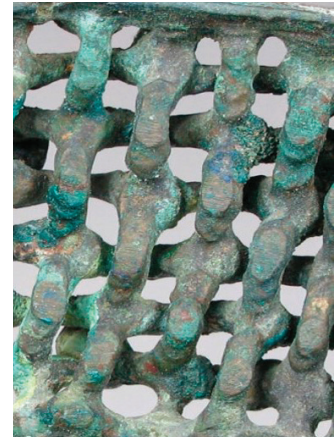

Figure 21. *Detail of interior of the lower hemisphere of the incense burner upper register (figs. 12 and 16), revealing vertical C-shaped forms.*

Triangles are carved out at each mold seam on A and used as pouring gates and vents. The assembled molds were fired, a core was then added, and it was cast creating the openwork dome. Since each quarter was made from the same molds (A and B), each quarter is identical to the others.

This can be seen on the incense burner when digitally overlaid. Each quarter of the hemisphere is identical, aligning perfectly with one another. The exterior horizontal rows and interior vertical rows of each quarter are identical matches to one another, including their slight irregularities (figs. 17 and 19). Traces of vertical mold seams can be found between the quarters with slight discontinuities (fig. 18). The remarkable precision to which they align suggests that the same mold was used to produce each quarter (figs. 17 and 19).

If this object was lost-wax-cast, how could it have been done? Since each outer section is identical, the same model or pattern was used. Was this made by pushing wax or resin into the mold to make four exact duplicates? Any wax pressed onto the model or outer mold would have to be removed and placed onto the core or inner mold. But this thin design, if removed from a mold, would be too flimsy. There would be distortions, pinching, slumping, or other indications of where sections were joined. There are none. Every row, vertical and horizontal, front and back, lines up perfectly.

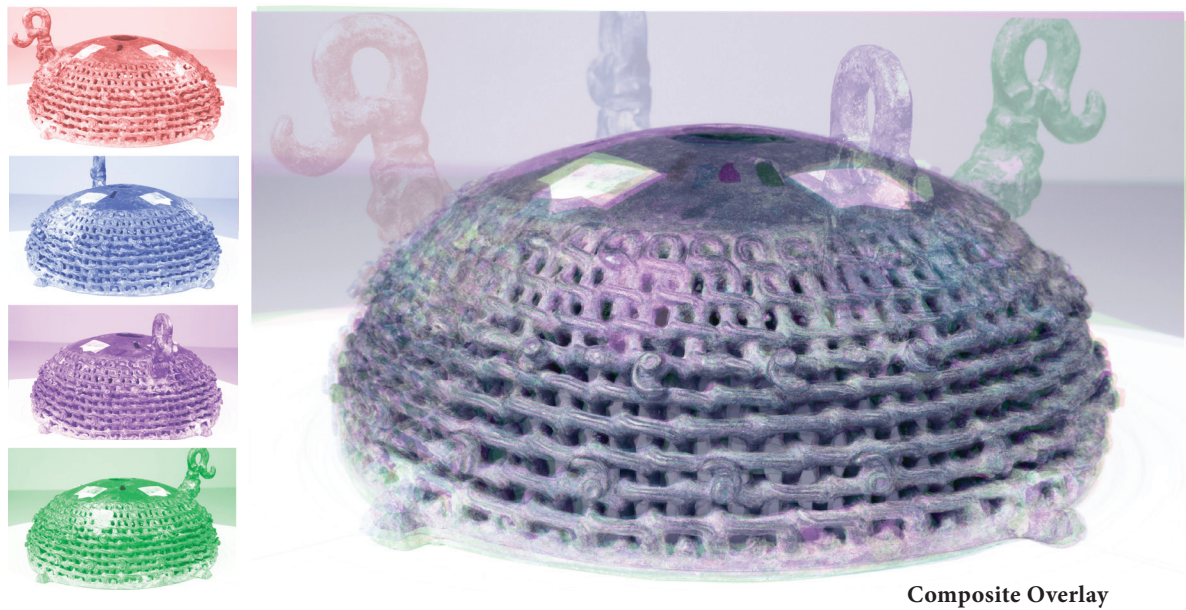
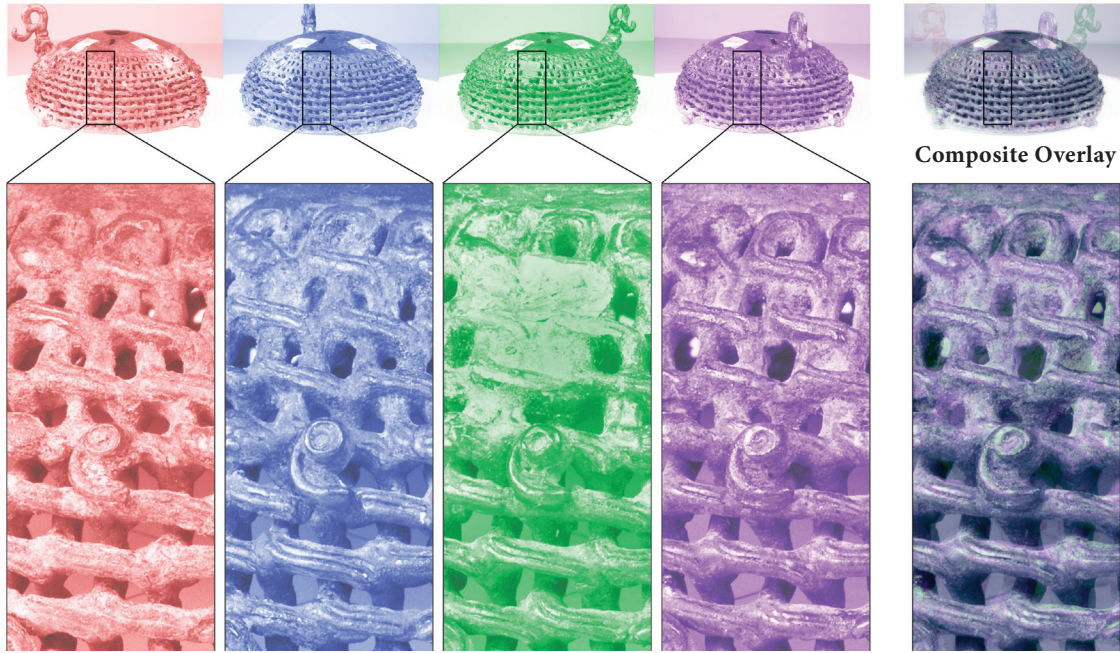

Figure 17. Digital quarter sections of the lower hemisphere of the incense burner; each quarter is indicated by a different color (fig. 12). All four quarters are overlaid in the larger image, demonstrating that the same mold was used for each quarter.

Figure 19. Details of each quarter in figure 17. The four images are overlapped in the fifth image, revealing remarkable symmetry both on the horizontal and vertical rows. Figures 17 and 19 photos by Donna Strahan/Objects Conservation/Image © The Metropolitan Museum of Art. Color by Soon Kai Poh.



Sackler finial

Another example, examined by the author, is a finial in the Arthur M. Sackler Gallery (RLS1997.48.417) (fig. 22). The front appears to have been formed in a mold because of its smooth, fine-detailed design. However, the back is similar to the Metropolitan incense burner with the stepped C-shaped pattern (figs. 21 and 23). X-ray fluorescence analysis found all parts were made of a similar high-lead, copper-tin alloy. There was no solder. Thus regardless of the casting method, the finial was cast in one piece in a single pour.

A similar C-shaped pattern can be seen on the interior of an Eastern Zhou bronze tray recently uncovered in tomb 30 of the Zeng Kingdom Wenfengta cemetery, Suizhou, Hubei province, and attributed to the Marquis Bing of Zeng, a relative of the Marquis Yi (China Culture Relics News Press 2016) (fig. 24). The same pattern found on the Metropolitan incense burner (see fig. 21) and the Sackler finial (see fig. 23) is also found on the interior of an openwork base in the Nanjing Museum (Wan 2013) (fig. 25). All were clearly made using a similar technique. While Zhou and Huang think they were piece-mold-cast (Zhou and Huang 2015b), most researchers say they are lost-wax-cast. I am not convinced that lost-wax casting could produce this repeated regular pattern. Creating these designs would be much more complicated if carried out in wax. It would be easier to weave wax strands into a basket than to have created exterior horizontal rows and interior vertical rows. If wax had been used, there would be more distortion and evidence of pinching or slumping.

The next step toward better understanding the casting method is to try to reproduce these designs. By actually trying to make the object, the method may become clear.



Figure 22.

Finial, Eastern Zhou dynasty, 6th–5th century BCE, bronze, H. 3 cm, W. 6.5 cm, D. 5.8 cm. Arthur M. Sackler Gallery, RLS1997.48.417. The Dr. Paul Singer Collection of Chinese Art of the Arthur M. Sackler Gallery, Smithsonian Institution; a joint gift of the Arthur M. Sackler Foundation, Paul Singer, the AMS Foundation for the Arts, Sciences, and Humanities, and the Children of Arthur M. Sackler.



Figure 23.
Detail of Sackler finial interior (fig. 22) showing stepped form. Photo by Donna Strahan.



Figure 24.
Detail of Zeng bronze tray interior, Marquis Bing of Zeng, tomb 33, Suizhou, Hubei, showing stepped form. After Zhou and Huang 2015a, 1635, fig. 10a.



Figure 25.
Detail of Nanjing base interior, showing stepped form similar to that in figures 20, 22, and 23. After Wan 2013, 72, 75, figs. 1, 6.

Met Dui

The last vessel to be considered is an early Eastern Zhou vessel at the Metropolitan Museum (1992.165.24) that has been examined by a number of scholars. Most agree that the body was piece-mold-cast (fig. 26). Examination by the author using X-ray radiography and binocular microscopy clearly revealed that the feet, body, and side handles were separately cast by the piece-mold method. They each have visible mold seam lines. These separately made pieces were either cast-on or soldered to the body. There are two side lugs cast with the body that originally had handles, now missing.

The lid and central top handle were cast separately (fig. 27). Radiography of the lid revealed metal spacers were used to separate the inner and outer mold sections, confirming it, too, was piece-mold-cast. Note that during casting the outer molds were not perfectly aligned, creating a thicker area that appears lighter in the radiograph. This difference also helps confirm the location of the lid mold sections.

Only the separately cast lid handle does not have any obvious seams or mold marks. It is attached to the lid mechanically by twelve stems that are inserted into holes in the lid. The bottom of the stems are visible on the interior of the lid with no evidence it was cast-on and no solder is visible on the surface or in the radiographs. The stems are likely part of the handle's casting gate and sprue system.

There is disagreement among scholars on how this handle was cast (Notis and Wang 2017). Lost-wax casting adherents suggest the thinning and curved joins between crossing elements in the interlacing confirm that a soft material was attached to itself at these points. Because the upper elements are thicker and at an angle in the radiograph the joins appear whiter, hence denser in the radiograph. This is confirmed in the X-radiograph (fig. 28). X-ray fluorescence analysis of the alloy across an area that appeared to be a join did not find any difference in the composition. All locations were leaded bronze with similar elemental peak heights in the XRF spectra.

Hua Jyeming suggests the multiple small design elements, such as the animal heads, were made in molds using a wax-like material. However, it would be very difficult to fit these separately made pieces onto the handle without distortion. The handle is so symmetrical with no distortion and with no evidence of pinching or slumping, yet there are no mold seams. Because it lacks mold lines and seams, the casting method of the handle is quite different from the incense burner and may be lost-wax-cast.

Top to bottom

Figure 26. Dui grain vessel, China, Eastern Zhou (6th century BCE), copper alloy, H. 20.3 cm. The Metropolitan Museum of Art, 1992.165.24. Image © The Metropolitan Museum of Art.



Figure 27. Detail of dui lid handle. The Metropolitan Museum of Art, 1992.165.24. Photo by Donna Strahan/Objects Conservation/ Image © The Metropolitan Museum of Art.



Figure 28. X-radiograph of dui lid handle. The Metropolitan Museum of Art, 1992.165.24. Photo by Donna Strahan/Objects Conservation/ Image © The Metropolitan Museum of Art.

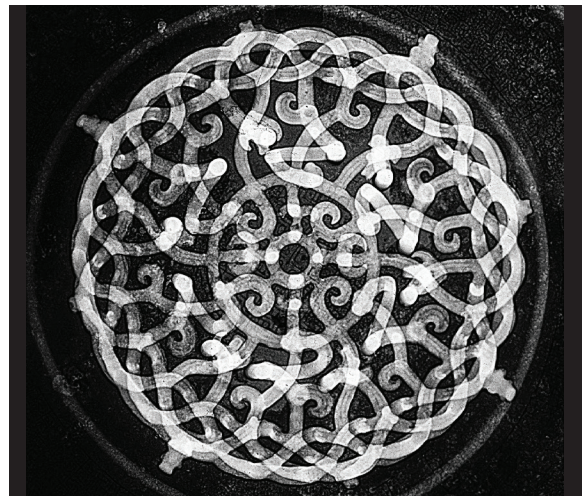

Conclusions

As Bagley noted, all these vessels were produced in a large centralized system of organized foundries that had refined their methods over the centuries. Their production implies an industrial scale with ample metal supplies, and most likely royal sponsorship (Bagley 2009, 90). The incense burner and other vessels are the outcome of a long series of technical innovations.

To date, both the Anyang foundry and Houma foundry debris demonstrate the piece-mold casting method was important in this region. Although no lost-wax casting foundries have been identified, an inlay adhesive on an excavated Eastern Zhou vessel was recently analyzed and identified as beeswax (Luo et al. 2012, 1235). This finding implies that wax was a useful material in the foundries, but was it used to create sections of bronzes?

These extraordinary openwork vessels never gained widespread popularity and remain rare and isolated pieces. There has not yet been enough study of them to prove whether they were made by piece-mold casting or by lost-wax casting, or both. We need more information about the organization of foundry processes, and more pieces need to have their joins X-radiographed and analyzed for any variation in alloy composition. There also needs to be more technical studies of Qin and Han dynasty objects that appear to be lost-wax-cast. It is my hope that this foray into the technological fabrication of these complex vessels adds a little to our understanding of ancient Chinese culture, but perhaps it just creates more questions. Potentially, there were multiple methods of casting. Clearly, there is much for future generations of researchers to do.

Acknowledgments

I am exceedingly grateful to the Asian Art Department of the Metropolitan Museum of Art for its support and access to these objects. I especially appreciate the reviewers' comments on piece-mold casting. I also thank all those researchers—those mentioned in the text and those who were missed—who continue to pose interesting questions about casting ancient bronzes.

Note

1. Minute bronze samples were taken. Mark T. Wypyski, Department of Scientific Research, Metropolitan Museum of Art, analyzed them quantitatively by energy dispersive and wavelength dispersive x-ray spectrometry in the scanning electron microscope (SEM-EDS/WDS). The analyses were performed with an Oxford Instruments INCA Energy 300 microanalyzer equipped with a Link Pentafet high-resolution Si(Li) SALTW EDS detector and a Microspec WDX-400 WDS spectrometer, operated with a LEO Electron Microscopy variable-pressure scanning electron microscope (model 1455VP). In summary, all of the pieces are cast of a similar leaded, copper alloy (74Cu, 14Sn, 11Pb) except for the feet (80Cu, 11Sn, 8Pb).

2. Alternatively, next, wet paint was applied over the negative image on mold A and pressed onto a second mold piece (B), leaving a pattern. This pattern provided a map for aligning holes to be made through B.

References

- Bagley, Robert. *Shang Ritual Bronzes in the Arthur M. Sackler Collections*. Washington, DC: The Arthur M Sackler Foundation and the Arthur M. Sackler Museum, 1987.
- Bagley, Robert. "Anyang Mold-Making and the Decorated Model." *Artibus Asiae* 69, no. 1 (2009): 39–90.
- Barnard, Noel. *Bronze casting and bronze alloys in ancient China*. Monumenta Serica Monograph Series 14, 1961.
- CCTV videos 2010. "National memory: Zenghouyi zun pan 1," YouTube video, <http://www.youtube.com/watch?v=MQaZ8nCS8ww> (accessed 12/6/2013).
- CCTV videos 2010. "National memory: Zenghouyi zun pan 2," YouTube video, <https://www.youtube.com/watch?v=MHD8-DDTOho> (accessed 12/6/2013).
- CCTV videos 2010. "National memory: Zenghouyi zun pan 3," YouTube video, <https://www.youtube.com/watch?v=dOXAKoOZJxc> (accessed 12/6/2013).
- Chase, William Thomas. *Ancient Chinese Bronze Art: Casting the Precious Sacred Vessel*. New York: China Institute in America, 1991.
- China Culture Relics News Press 2016. "The Zeng Kingdom Wenfengta Cemetery from the Eastern Zhou Dynasty (770–225 BC)." *Bridging Eurasia* (January 2016). Bridging-eurasia.org/en/node/347.
- Davey, Christopher J. "The early history of lost-wax casting." In *Metallurgy and civilization: Eurasia and beyond; Proceedings of the Sixth International Conference on the Beginnings of the Use of Metals and Alloys (BUMA VI)*, edited by Jianjun Mei and Thilo Rehren, 147–54. London: Archetype, 2009.
- Fairbank, Wilma. "Piece-mold Craftsmanship and Shang Bronze Design." *Archives of the Chinese Art Society of America* 16 (1962): 8–15.
- Fan, Taofeng, Wan Li, and Zhang Hui. "Discussion on manufacturing techniques of Chen Zhang Pot (special report)." *China Foundry* 10, no. 1 (2013): 1–6.
- Franklin, Ursula M. *The Real World of Technology*. Concord, Ontario: House of Anansi Press, 1992.
- Gettens, Rutherford J. *The Freer Chinese Bronzes, Vol. 2: Technical Studies*. Washington, DC: Smithsonian Institution, 1969.
- Hua, Jueming. "Zhong xi fang shi la fa zhi tong yi" [Comparison of lost-wax casting between ancient China and the West, and comments on the opinion that there was no lost-wax process in the pre-Qin period]. *Kaogu* 4 (2010): 87–96.
- Hua, Jueming, and Huifang Xiao. "Chu wang yu – yi zhi zhong guo zui zao de shi la zhu jian jian lun shi mo fa ji qi gong yi yan bian" [The earliest known lost-wax casting: The Yu vessel of the King Chu State and the technical evolution of lost-wax technology]. *Qing tong wen hua yan jiu* 4 (2005): 80–89.

- Huang, Jinzhou. “Zenghouyi zun pan cao yong shi la fa gong yi zhu zao wu yong zhi yi – yu <<zhong guo qing tong shi dai bu cun zai shi la fa zhu zao gong yi >> tao lun” [Evidence for using the lost-wax casting technique to make the Zun and Pan vessel of the Marquis Yi of Zeng]. *Jiangnan Kaogu* 4 (2008): 109–17.
- Huang, Yawei, Pan Lu, Chuanwen Wan, Weirong Zhou, and Changsui Wang. “Zai tan Zenghouyi zun pan de zhu zao gong yi” [Rediscovering the casting technique of the Zenghouyi *zun* and *pan*]. *Zhongyuan Wenwu* 1 (2008): 97–107.
- Jing, Hongwei, and Zhouying Wang. “Fengxiang fa xian zhan guo feng niao xian huan tong xun lu” [Bronze incense burner with phoenix motif from Warring States period unearthed in Fengxiang county]. *Wenbo* 70 (1996): 57.
- Karlbeck, Orvar. “Anyang Moulds.” *Bulletin of the Museum of Far Easter Antiquities* 7 (1935): 39–60.
- Kerr, Rose, and Nigel Wood. “Chemistry and chemical technology.” In *Science and Civilization in China* 5, part XII, *Ceramic technology*. Cambridge: Cambridge University Press, 2004.
- Keyser, Barbara W. “Décor Replication in Two Late Chou Bronze ‘Chien.’” *Ars Orientalis* 11 (1979): 127–62.
- Li, Chi. “Anyang fa jue bao gao” [Preliminary reports of excavations at Anyang]. *Academia Sinica, Institute of History and Philology*, no. 1-2 (Peking, 1929), no. 3 (Peking, 1931), no. 4 (Shanghai, 1933).
- Li, Chi. *Anyang*. Seattle: University of Washington Press, 1977.
- Li, Chi, and Chaipao Wan. “Yin xu chu tu qing tong gu xing qi zhi yan jiu” [Studies of the bronze gu-beaker excavated from Hsiao-t’un and Hou Chia Chuang: Its casting process and decorative patterns]. *Archaeologia Sinica* 1 (1964).
- Li, Xiating, and Ziming Liang. *Art of the Houma Foundry: Institute for Archaeology of Shanxi Province*. Princeton: Princeton University Press, 1996.
- Li, Xueqin. “Beginning of the Use of Lost Wax Casting in Spring and Autumn Period.” In *The Wonder of Chinese Bronzes*, 64. Beijing: Foreign Language Press, 1980.
- Li, Yuanzhi, Fangtao Chang, Derui Tan, Jueming Hua, and Mingwu Zhang. “Xu gong ning tou kong pan hui wen qing tong shi jian – xian qin shi la fa zhi yi qi li” [Xu Gong Ning openwork bronze ornament with snake design]. *Zhong Yuan Wen Wu* 1 (2007): 96–103.
- Loveday, Helen. “Diversity in Eastern Zhou bronze casting: A look at a group of openwork vessels.” *Journal of East Asian Archaeology* 4, no. 1 (2002): 101–42.
- Luo, Wugan, Lao Li, Changsui Wang, and Fengchun Huang. “Discovery of Beeswax as binding agent on a 6th-century BC Chinese Turquoise-inlaid Bronze sword.” *Journal of Archeological Science* 39, no. 5 (2012): 1227–37.

Notis, Michael R., and Dongning Wang. “Ancient Chinese Bronze Casting Methods: The Dilemma of Choice.” *MRS Advances* 2, no. 33–34 (2017): 1743–68.

Peng, Peng. “A Study on the Origin of Chinese Lost-Wax Casting from the Perspectives of Art, Technology, and Social Agency.” *Sino-Platonic Papers* 265 (January 2017): 1–44.

Strahan, Donna K. “An Enlightened Journey: Transitions in Casting of Chinese Buddhist Images.” In *Scientific Research on Ancient Asian Metallurgy*, edited by Blythe McCarthy, Paul Jett, and Janet G. Douglas, 73–82. London: Archetype Publications, 2012.

Tan, Derui. *Can lan de zhong guo gu dai shi la zhu zao* [The splendid craft of lost-wax casting in ancient China]. Shanghai: Shanghai Scientific and Technological Literature Publishing House, 1989.

Tan, Derui. “Zhong guo zao qi shi la zhu zao wen ti de kao cha yu si kao” [Pondering the origins of lost-wax casting in ancient China]. *Nan fang wen wu* 2, no. 2 (2007): 36–40.

Wan, Li. “Nan jing bo wu guan zang zhan guo tou kong pan long wen qing tong qi” [The Warring States bronze with openwork coiled dragon collected by Nanjing Museum]. *Dongnan Wenhua* 6, no. 236 (2013): 72–76.

Wang, Jinhui. “Tan Zenghouyi zun pan de zhu zao gong yi” [An introduction on the casting technique of Zenghouyi zun-pan]. *Dongnan Wenwu* 1 (2002): 70–74.

Zhang, Changping. “Guan yu Zenghouyi zun pan shi fou cai yong shi la fa zhu zao zheng lun de shu pin” [A review of the discussion of whether the lost-wax technique was used on the Zenghouyi vessel]. *Jiangnan Archaeology Quarterly* 4 (2007): 85–90.

Zhou, Weirong, et al. “Zhong guo qing tong shi dai bu cun zai shi la fa zhu zao gong yi” [No lost-wax casting technology in Chinese Bronze Age]. *Jiangnan Archaeology Quarterly* 2 (2006): 80–85.

Zhou, Weirong, et al. “New research on lost-wax casting in China.” In *Metallurgy and civilization: Eurasia and beyond; Proceedings of the Sixth International Conference on the Beginnings of the Use of Metals and Alloys (BUMA VI)*, edited by Jianjun Mei and Thilo Rehren, 73–78. London: Archetype Publications, 2009.

Zhou, Weirong, and Huang Wei. “Lost-wax casting in ancient China: New discussion on old debates.” *Journal of the Minerals, Metals and Materials Society* 67 (2015a): 1629–36.

Zhou, Weirong, and Huang Wei. “Tao lun qing tong shi dai tou kong qing tong qi de gong yi te se – jian tan shi la zhu zao wen ti” [A preliminary study of technical features of openwork bronzes from Bronze Age China and a brief discussion on lost-wax casting]. *Journal of National Museum of China* 1 (2015b): 147–55.

About the author

Donna Strahan is Head of the Department of Conservation and Scientific Research, Freer Gallery of Art and Arthur M. Sackler Gallery, Smithsonian Institution. The essay is a revised version of a lecture presented at the Forbes Lecture on Scientific Research in the Field of Asian Art in the Freer Gallery of Art on January 15, 2015.

